



4062249 Kiiltojet C2SP Spray cleaning unit





Hygiene Unit PROWASH - Installation

GB

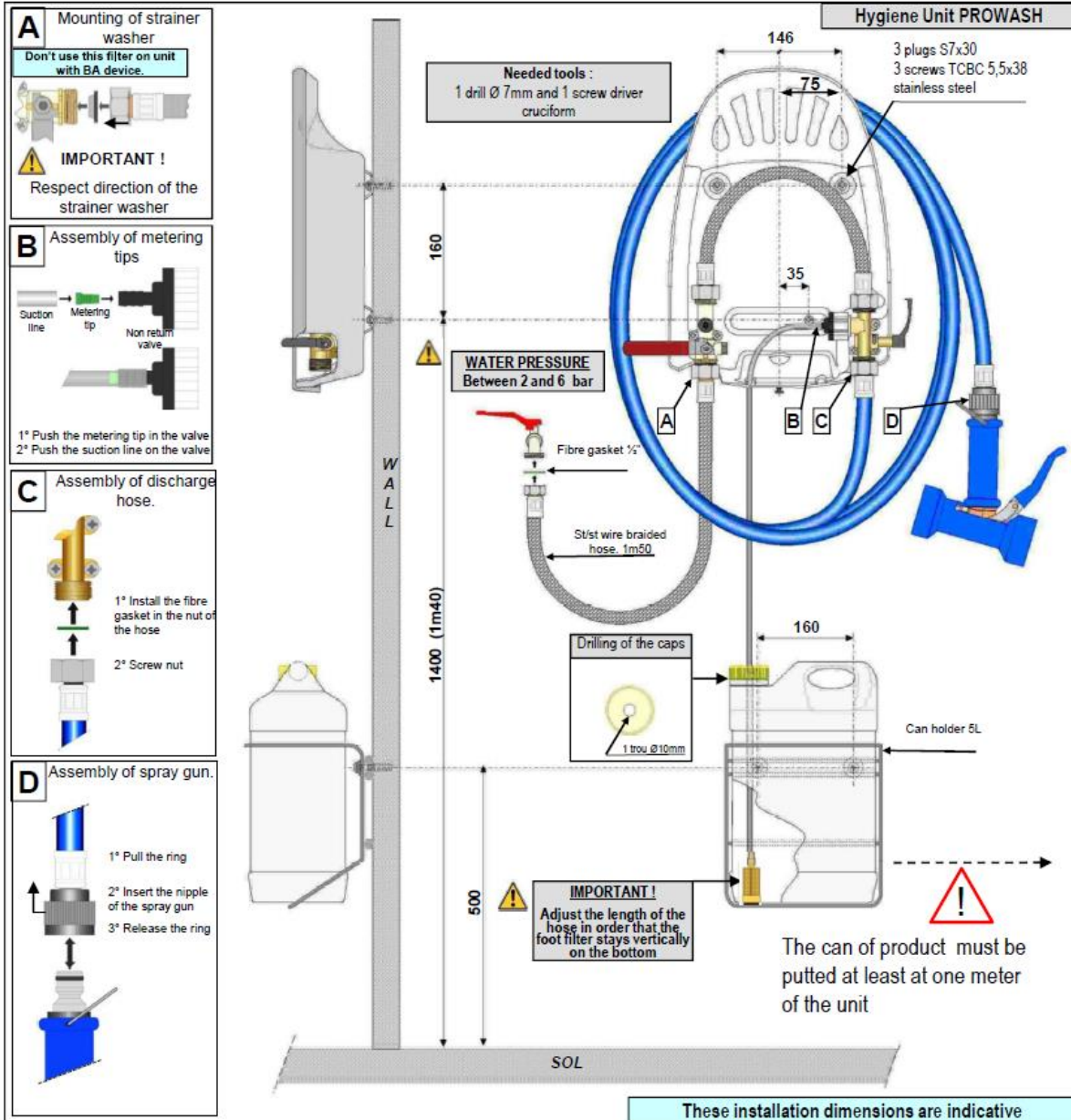

© All rights reserved

PACKING LIST – HYGIENE UNIT PROWASH		
1 Hygiene Unit PROWASH (1 or 2 products)	1 connection kit	1 (2) Suction line L=2m.
1 Stainless steel wire braided hose. F 1/2 - F 3/4 L= 1,5m		1 (2) Foot filter with weight.
1 Discharge hose with connection L= 10, 15, 20 or 25 m (depends on model)		1 (2) Bag with 14 metering tips.
1 Blue Spray gun		1 Green injector.
1 or 2 can holders 5 litres (depends on model)	1 kit with screw and o-rings.	1 Strainer washer 3/4".
1 Technical data sheet		2 fibre gaskets 1/2".
Dimensions of the box (L x l x h) : 450 x 390 x 290 mm		2 fibre gaskets 3/4".
Weight unit (hose 10m) = 7 Kg		5 (7) st/st screws. Ø 5,5 x 37.
Weight unit (hose 15m) = 8,3 Kg		5 (7) Plastic plug type : S7.
Weight unit (hose 20m) = 9,5 Kg		2 (4) st/st washer type : L5
Weight unit (hose 25m) = 10,5 Kg		



Centrale PROWASH – Instructions for use

GB

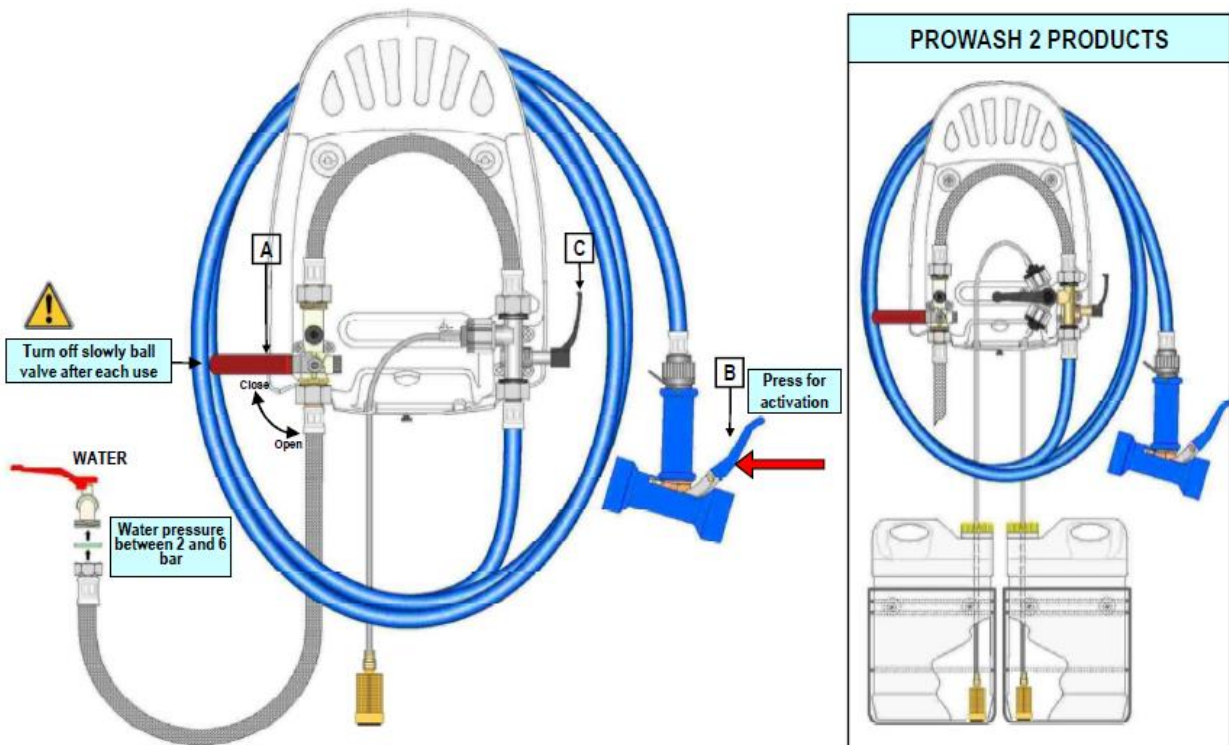

© All rights reserved

- ### USE
- 1) Open slowly the main water ball valve "A"
 - 2) Press lever "B" of the spray gun.
 - 3) Turn down the lever "C" for switching on "WASH" mode.
 - 4) Choose product 1 or 2 (only for version 2 products).
 - 5) Wait a few seconds until the detergent comes up in the suction line.
 - 6) Spray as requested.
 - 7) Lift up the lever "C" for switching on "RINSE" mode.
 - 8) Rinse.
 - 9) Turn off slowly the main water ball valve "A" after each use.

METHOD OF DILUTION CALCULATING

EXAMPLE: $\frac{15 (A)}{1000 (B)} \times 100\% = 1.5\%$ (this drawing is an example)

Volume A
(15 cl ou 150 ml)

Volume B
(1000 cl ou 10 000 ml)

Volume A : sucked product
Volume B : solution (water + product)

- ### CAUTION
- ⚠ ALWAYS orientate spray in direction of surfaces to treat.
 - ⚠ Chemical compatibility of used product **MUST ALWAYS** be checked.
 - ⚠ **NEVER** orientate spray in direction of people, animals or plants.
 - ⚠ ALWAYS wait few seconds for a good product and water mixing.
 - ⚠ ALWAYS close water inlet valve after each use.
 - ⚠ **WATER PRESSURE** must be included on 2 bar to 6 bar.
 - ⚠ **MAXIMUM** working temperature is 50°C
 - ⚠ ALWAYS keep the unit on frost protection
 - ⚠ ALWAYS pay attention to the risk of breakage if the device falls.

DILUTION CHART - HYGIENE UNIT PROWASH

pink	0,44%	blue	5,97%
purple	0,88%	white	6,65%
turquoise	1,42%	red	8,85%
yellow	1,59%	beige	11,87%
dark brown	2,12%	black	13,36%
orange	2,46%	grey	13,67%
green	3,30%	without tip	14,04%
light brown	4,67%	transparent	

This chart is done to allow you choose a tip in function of the needed concentration.

Conditions tests:
 20m hose + blue gun
 Green venturi injector
 Dynamic water pressure = 3 Bar (cold water)



Centrale PROWASH – Troubles

GB

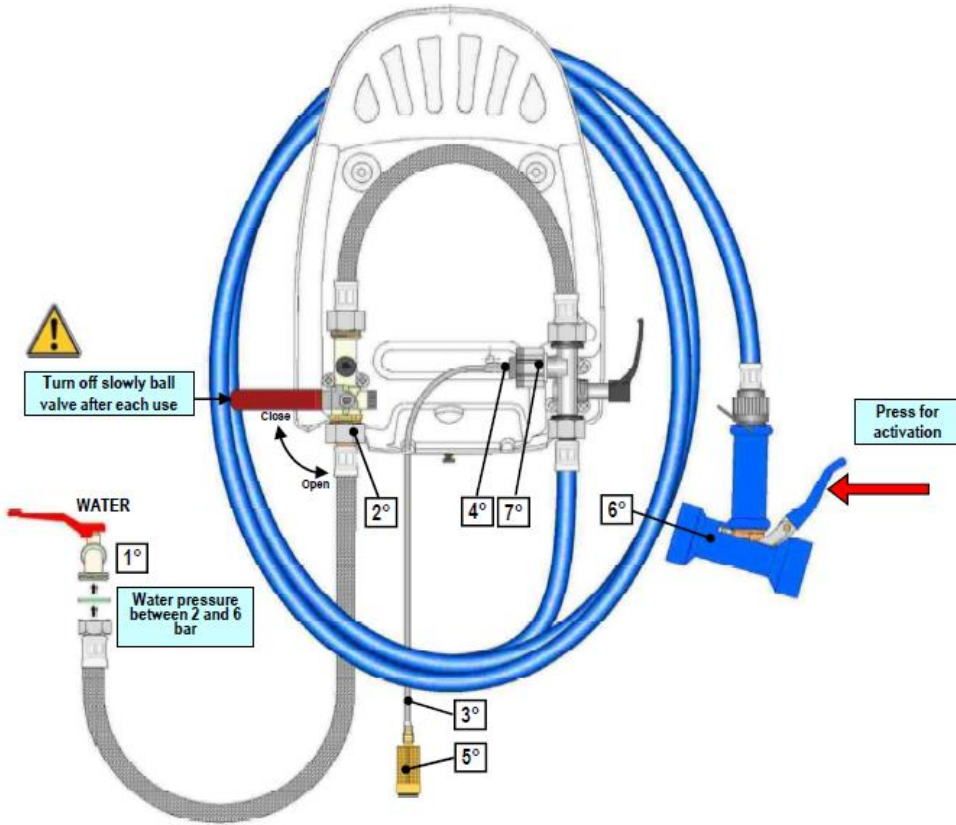

© All rights reserved

MAINTENANCE

Hygiene Unit PROWASH doesn't suck product

- 1° Check the pressure of the water system (minimum : 2 bar, max : 6 bar)
- 2° Check that the filter gasket is not dirty or scaled. (clean or replace)
- 3° Check that the yellow filter of the suction line is submerged in the product, and the hose is not pinched, folded, or closed.
- 4° Verify that the tip is not clogged. (clean or replace)
- 5° Check that the yellow filter of the suction line is not dirty. (clean or replace)
- 6° Check that the spray handle is not dirty or calcified. (clean or replace)

The can fills up with water

- 7° Verify that the check valve is not dirty or calcified. (clean or replace)

CLEANING of the Non Return Valve

Ceramic ball / O-ring

CLEANING or REPLACEMENT of the filter gasket

- 1_ Unscrew the nut of the stainless steel hose
- 2_ Clean or replace the strainer washer
- 3_ Reassemble the filter gasket

RESPECT ORIENTATION

CLEANING or REPLACEMENT of the venturi

1° Flat nose pliers / Plot

GREEN INJECTOR

2°

LOGOS

- 1 Open the water inlet valve
- 2 « Washing » mode valve
- 3 Spray (water + product)
- 4 « Rinsing » mode valve
- 5 Spray (water)
- 6 Close the water inlet valve

« Washing » mode

« Rinsing » mode

Do not drink the water

Maximum working temperature : 50°C



Hygiene Unit PROWASH - Description

GB

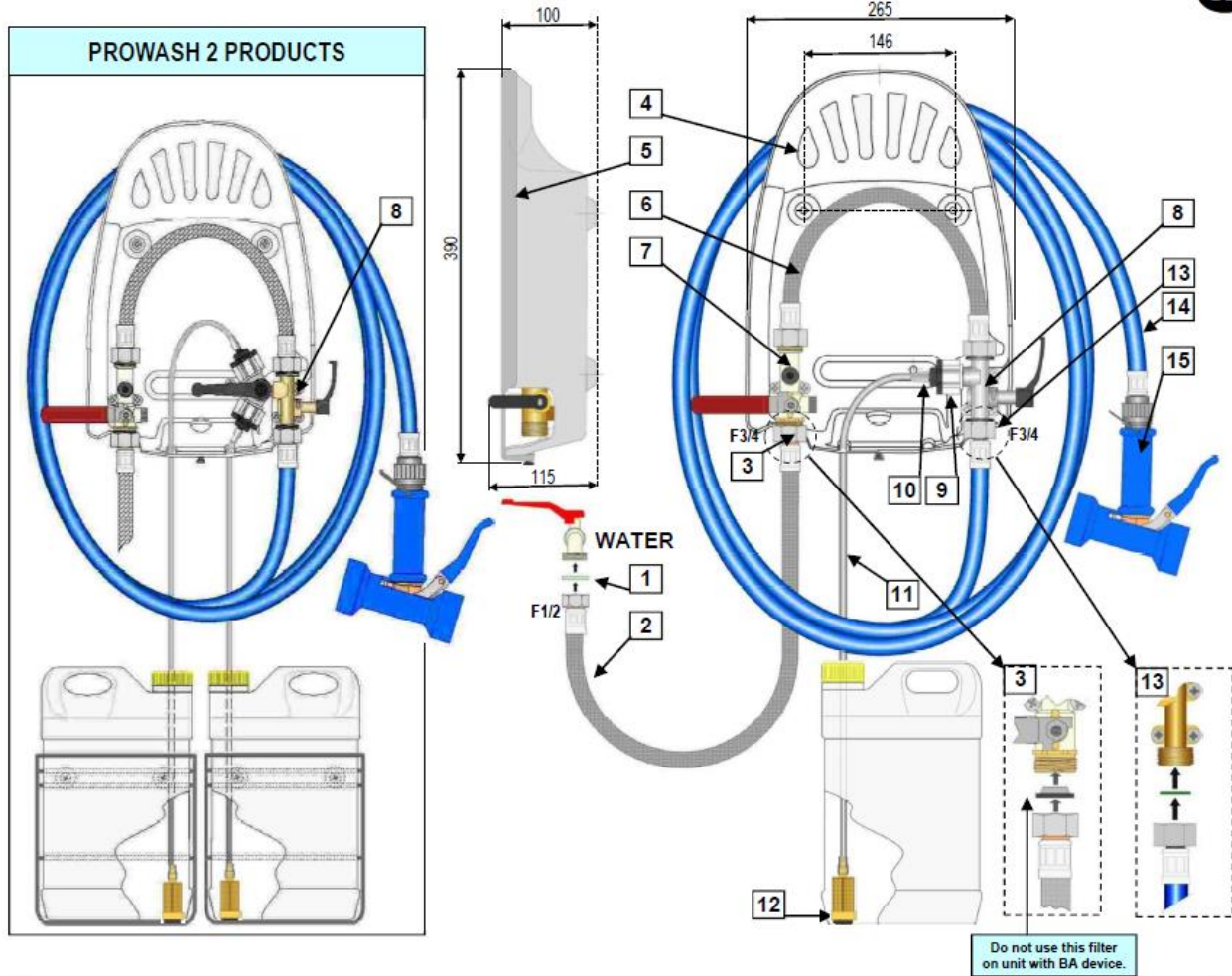

© All rights reserved

The Hygiene Unit PROWASH is designed for a intensif cleaning and disinfection of floors and surfaces.

SPARE PARTS HYGIENE UNIT PROWASH	
Description	Index
Fibre Gasket 1/2" (pack of 10)	1
Stainless steel wire braided hose. F1/2 x F3/4 L : 1,5m	2
Strainer washer 3/4" black (bag of 5)	3
Back plate for hygiene unit 1 or 2 products (PVC)	4
Cover with printing for hygiene unit 1 product (PVC)	5
Cover with printing for hygiene unit 2 products (PVC)	5
Hydraulic hose hygiene unit	6
Anti pollution ball valve	7
Venturi 1p+1 NR valve+green injecor+ EPDM o'ring	8
Venturi 2p+2 NR valve+green injecor+ EPDM o'ring	8
Non return valve Black / Grey (EPDM)	9
Metering tips (pack of 14)	10
Suction Line L: 2m	11
Foot filter with weight	12
Fibre gasket 3/4" (pack of 10)	13
Blue hose with connections 10m	14
Blue hose with connections 15m	14
Blue hose with connections 20m	14
Blue hose with connections 25m	14
Blue spray gun with nipple	15

Cover with PROWASH printing
1 Product



Cover with PROWASH printing
2 Products





HYGIENE UNIT PROWASH - VERSION WITH BA DEVICE

GB

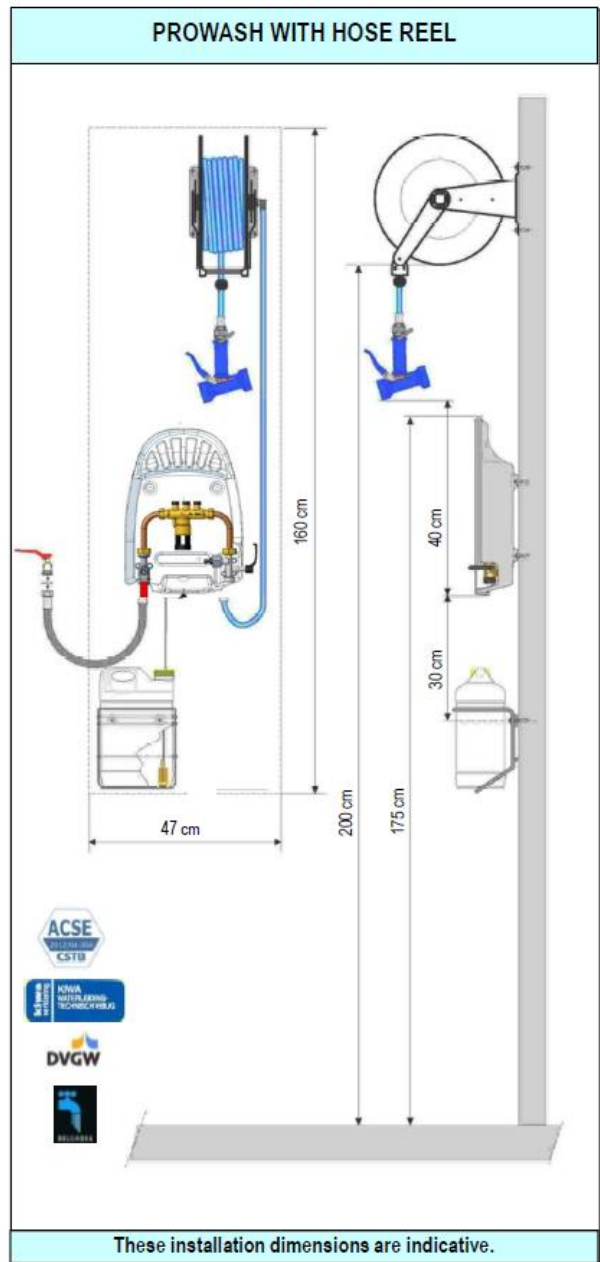
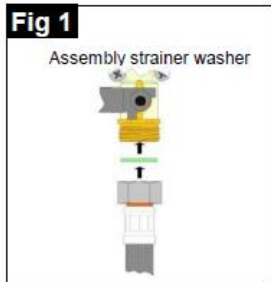
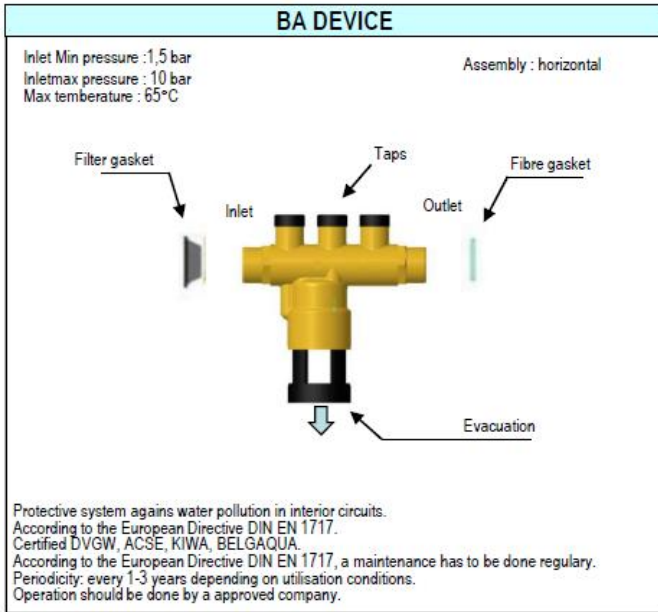

N° DE CERTIFICAT	DVGW	ACSE	KIWA	BELGAQUA	WRAS	TZW	W270	SVGW
Stainless steel hoses	DW-0304C00032	16 ACC NY 172			1004514			
Fibre Gasket	NG-5123BL0583							
Ball valve						KA 103A/11 KA 0329/12 KA 0049/15	MO 15/11 MO 093/11 MO 117/13	
BA	DW-6305CS0117		K10 1242/01	Belg 17/ 196/BA				1706-6632
Device + CA		12/04-003						
Device + BA	AS-0625C00308	12/04-004	K23 111/04	Belg 16/2 18/06				



HYGIENE UNIT PROWASH – PISTOPLAV VERION

GB

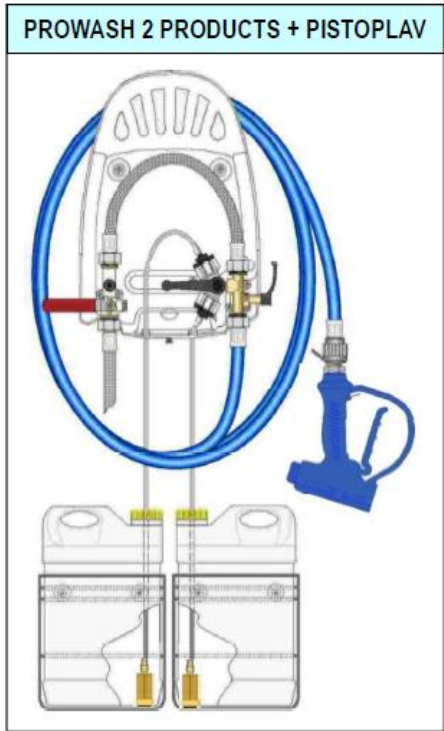
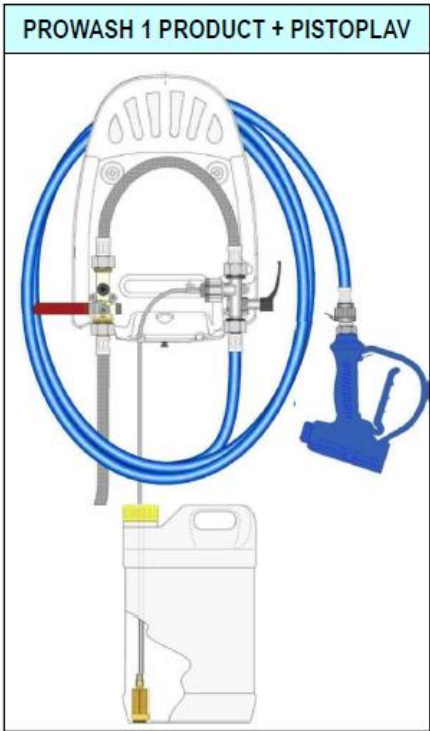

© All rights reserved

